

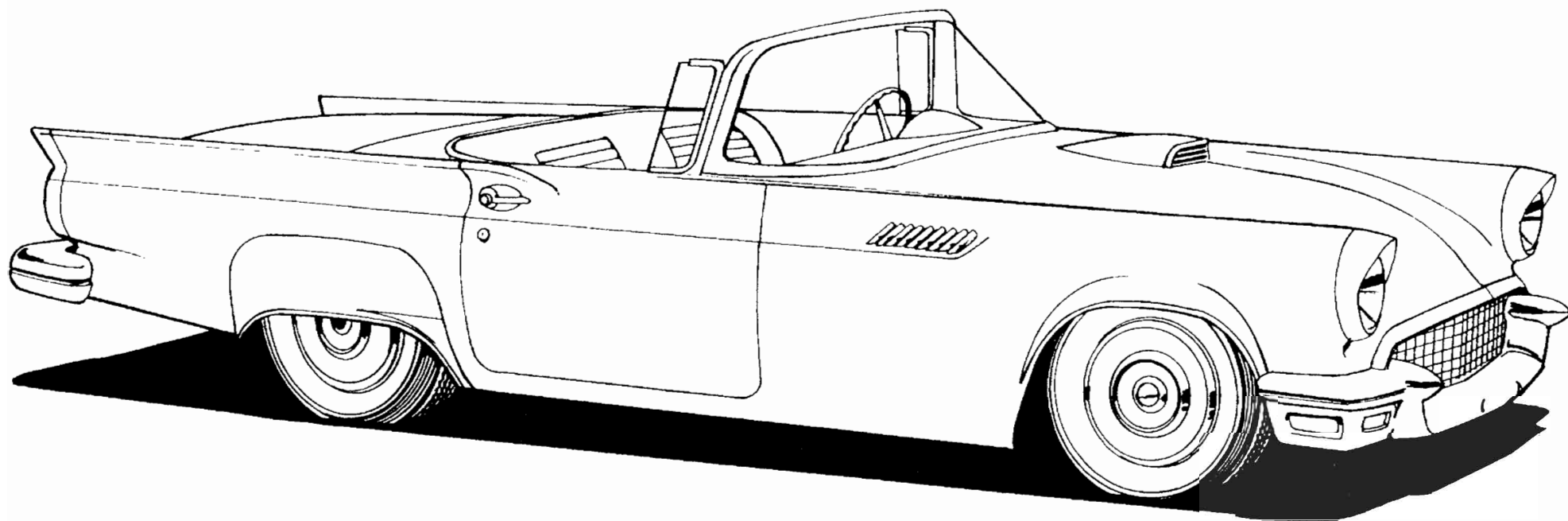

**World leaders in
automotive
finishes.**



1957 THUNDERBIRD



**World leaders in
automotive
finishes.**

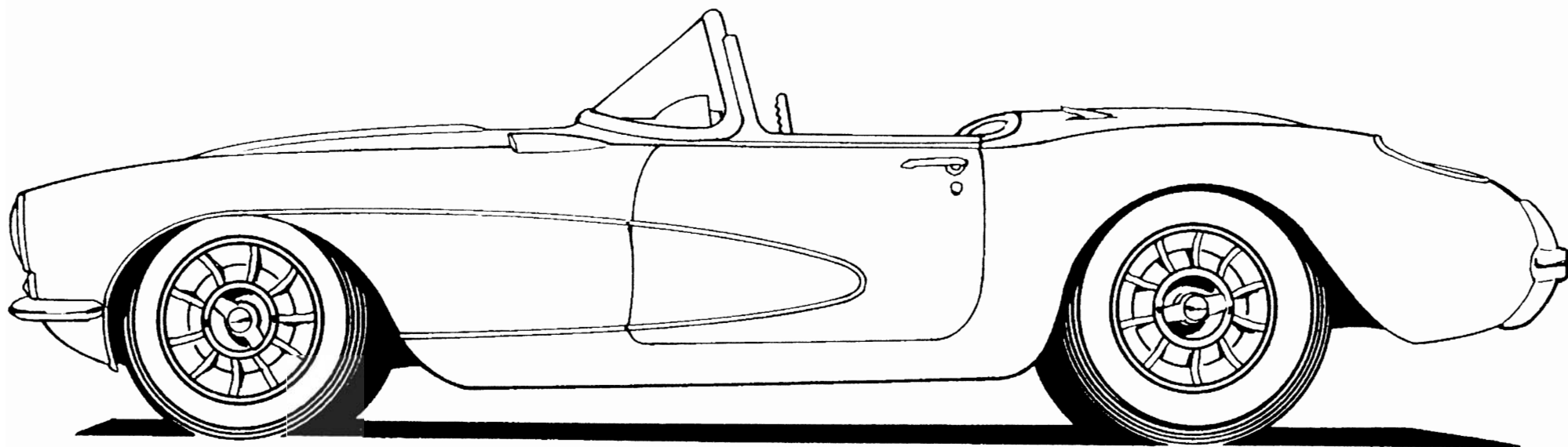

1957 CORVETTE



**World leaders in
automotive
finishes.**

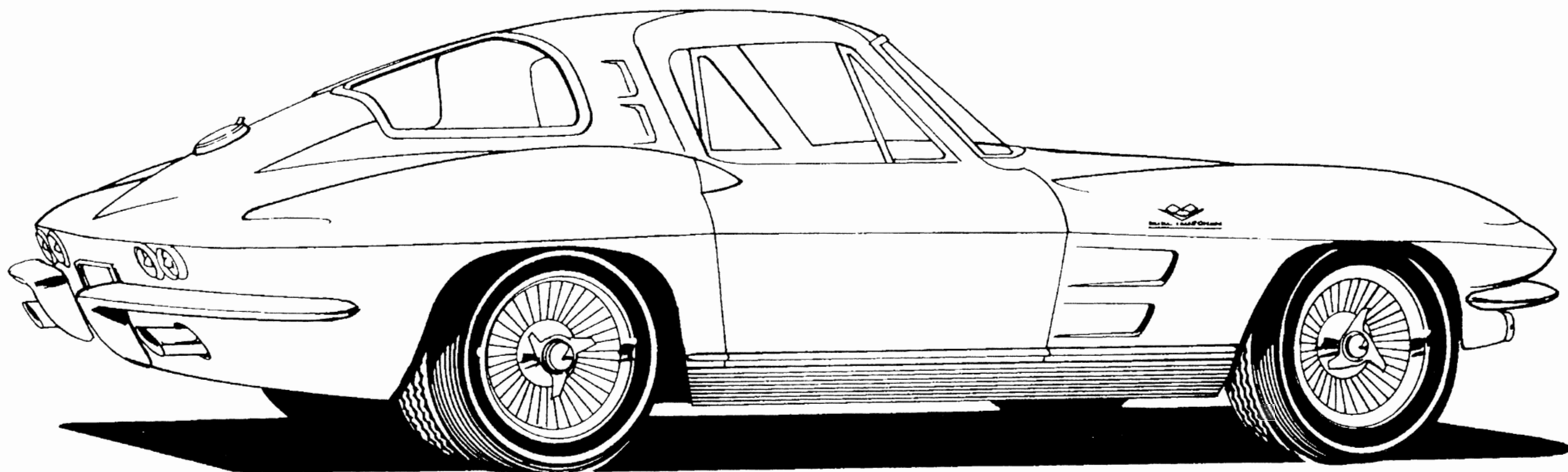

1963 CORVETTE



***World leaders in
automotive
finishes.***

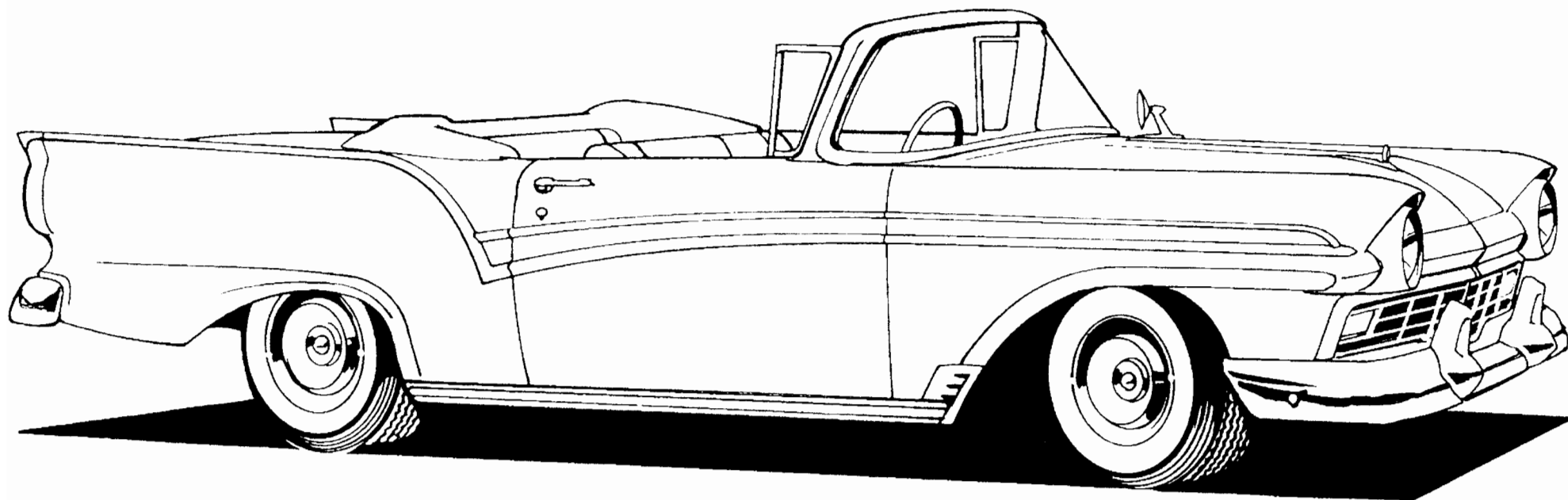

1957 FORD SUNLINER



**World leaders in
automotive
finishes.**

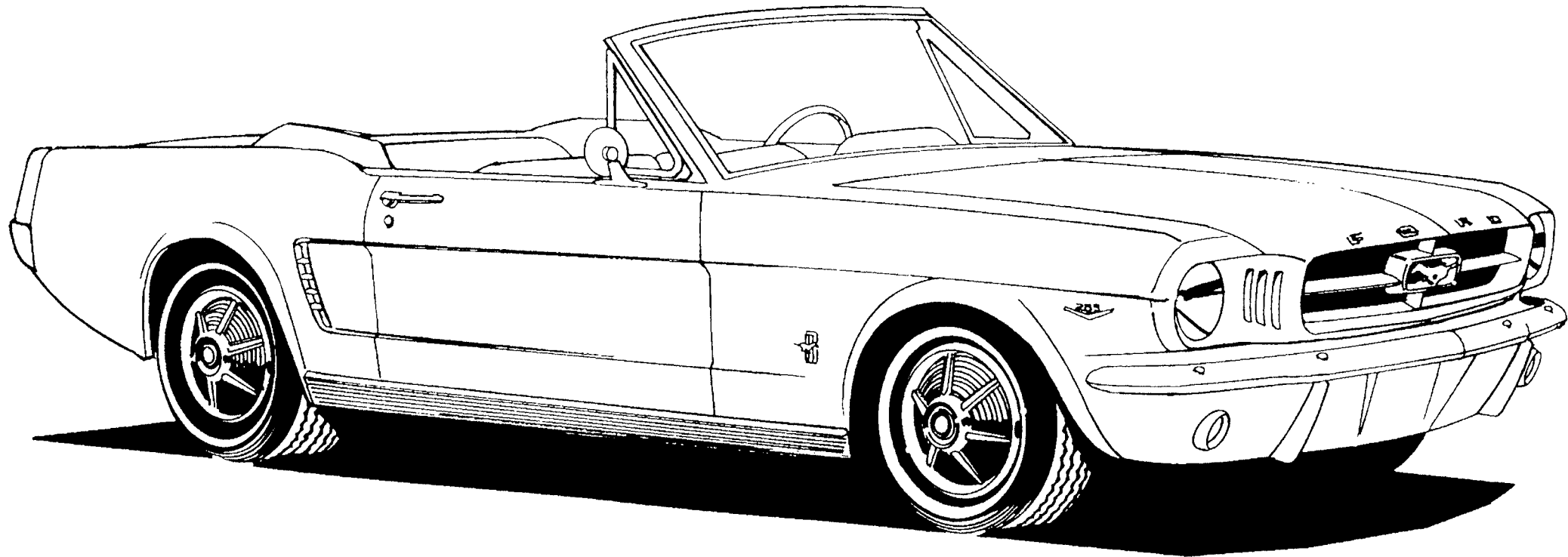

1965 MUSTANG CONVERTIBLE



**World leaders in
automotive
finishes.**

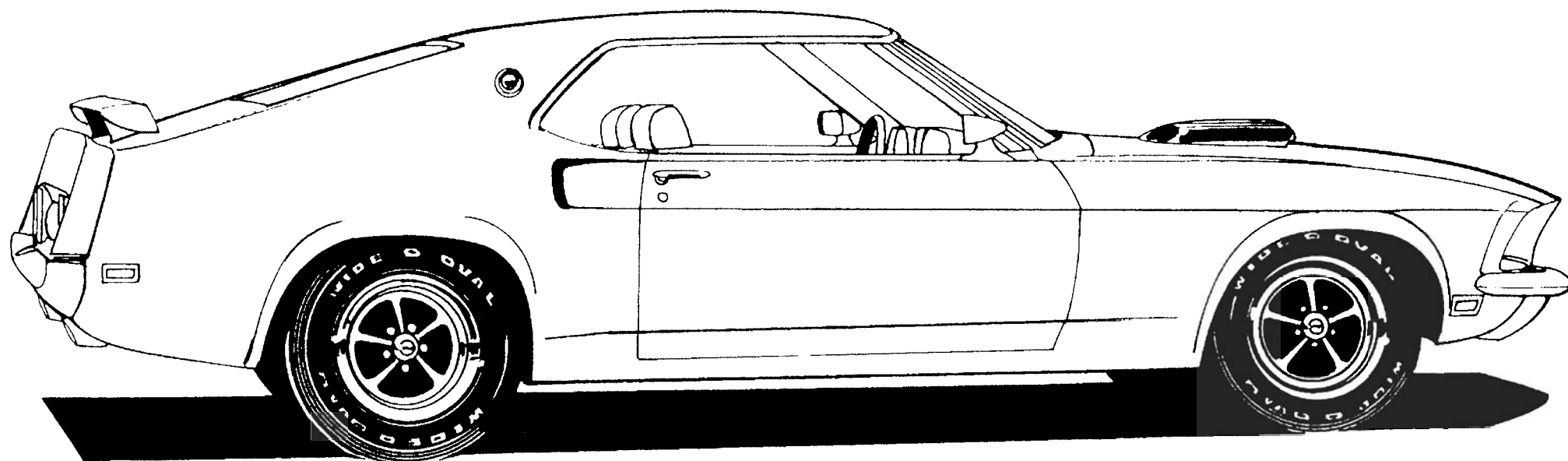

1969 MUSTANG BOSS 429



**World leaders in
automotive
finishes.**

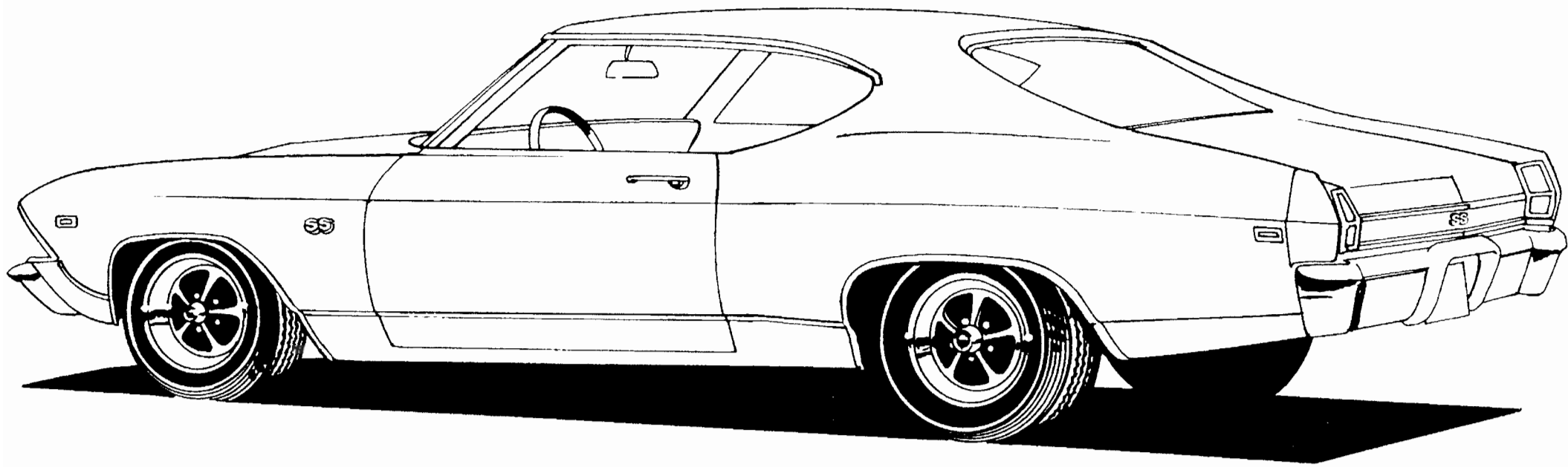

1969 CHEVELLE SS 396



**World leaders in
automotive
finishes.**

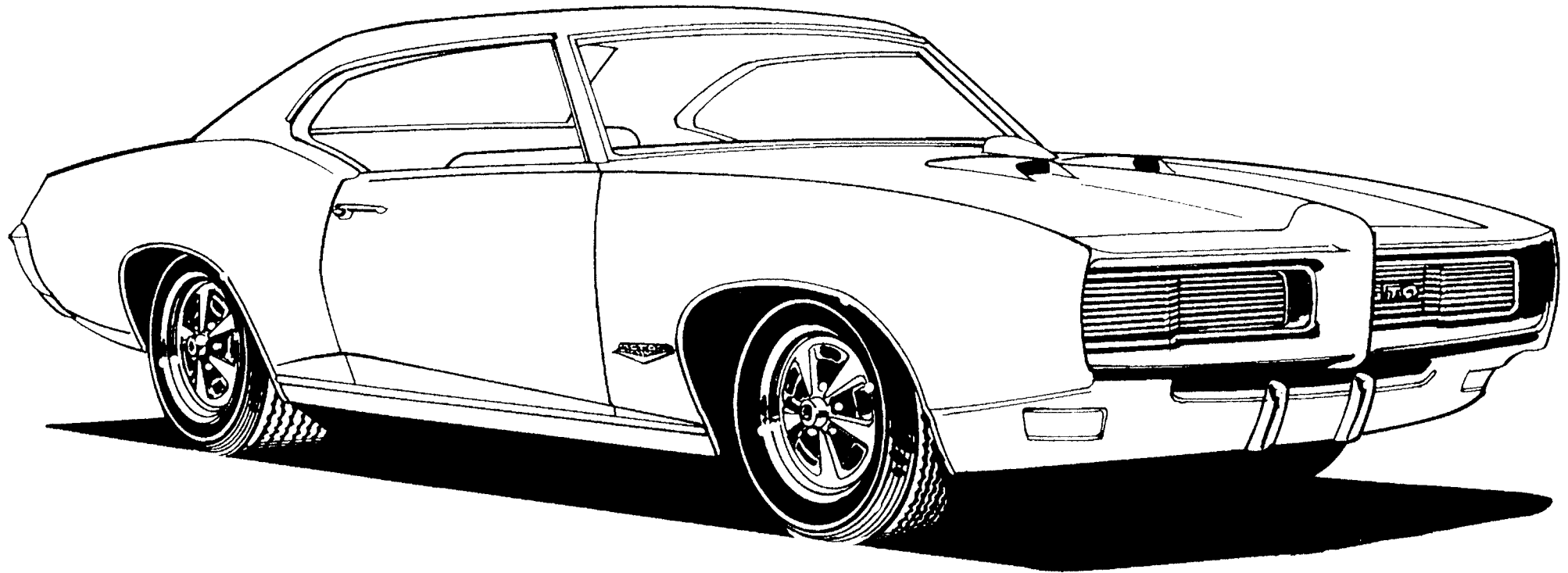

1969 GTO 400



**World leaders in
automotive
finishes.**

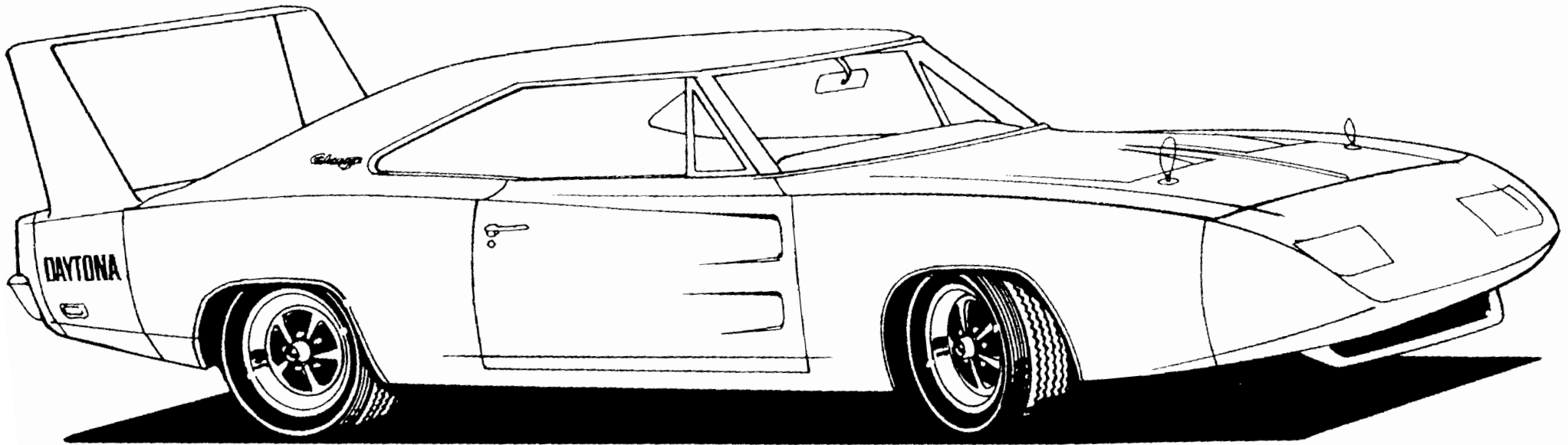

1970 DAYTONA CHARGER



**World leaders in
automotive
finishes.**

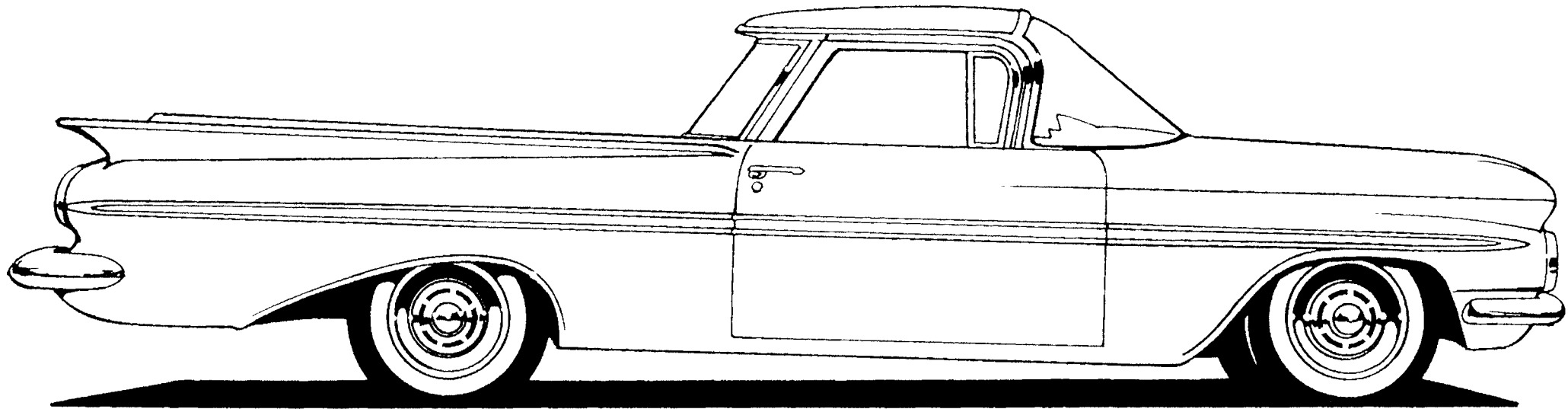

1959 CHEVY EL CAMINO



**World leaders in
automotive
finishes.**

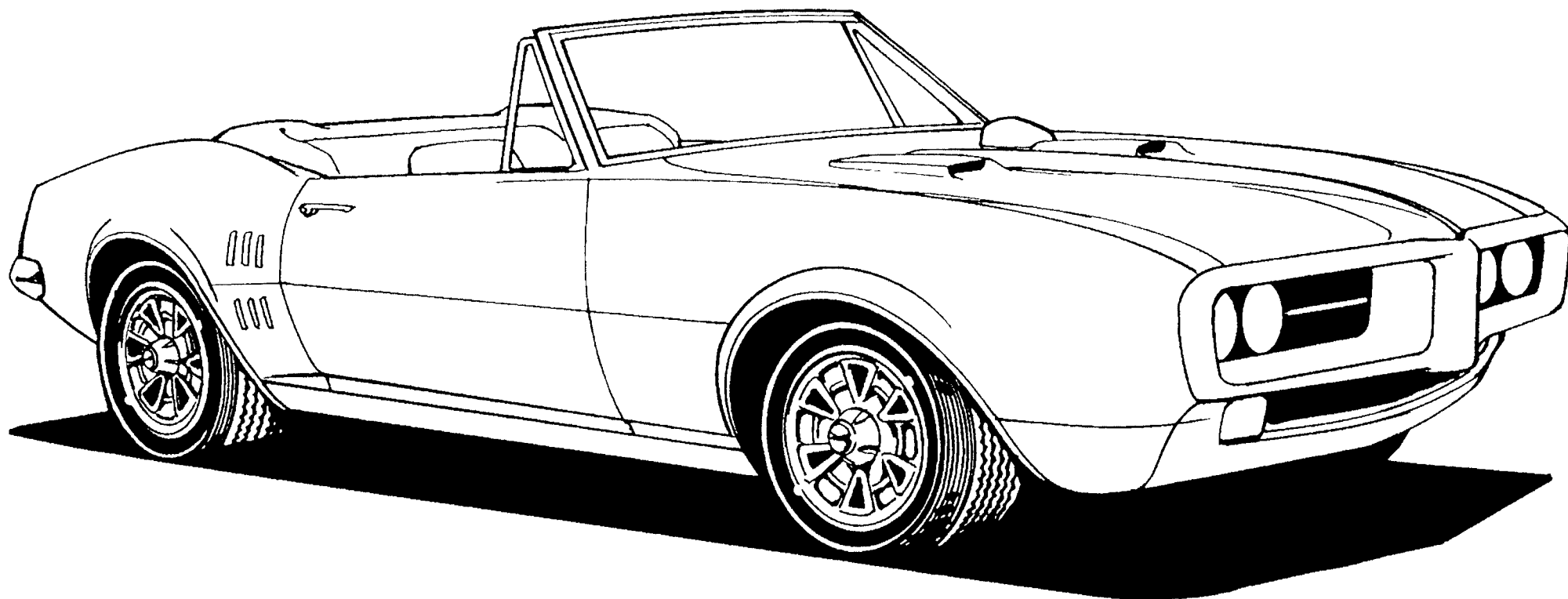

1967 FIREBIRD CONVERTIBLE



**World leaders in
automotive
finishes.**

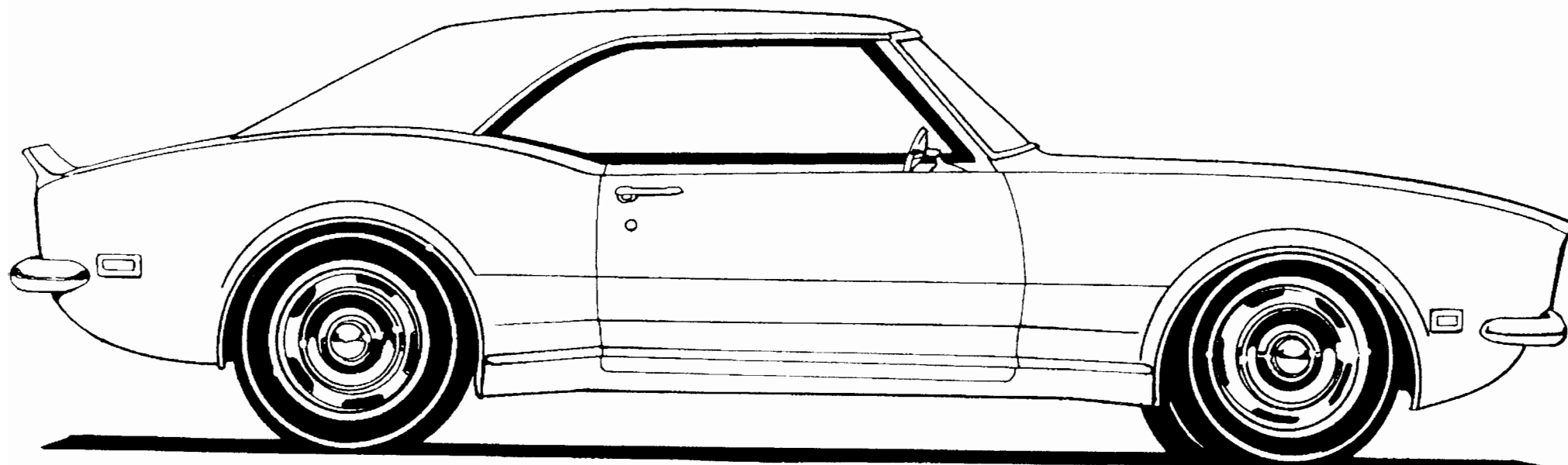

1968 CHEVY CAMARO



**World leaders in
automotive
finishes.**

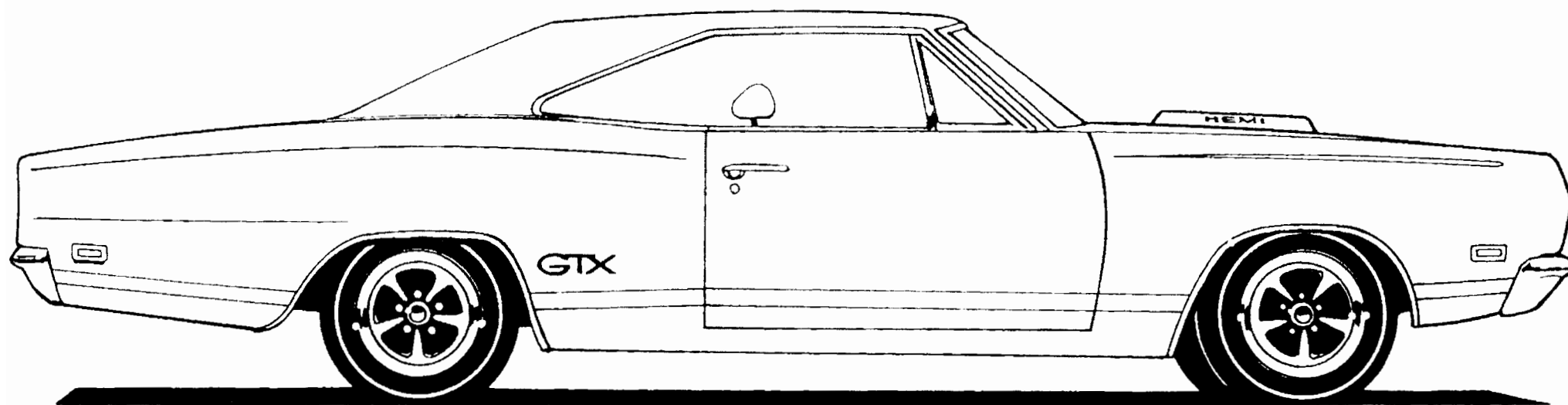

1969 PLYMOUTH GTX HEMI



**World leaders in
automotive
finishes.**

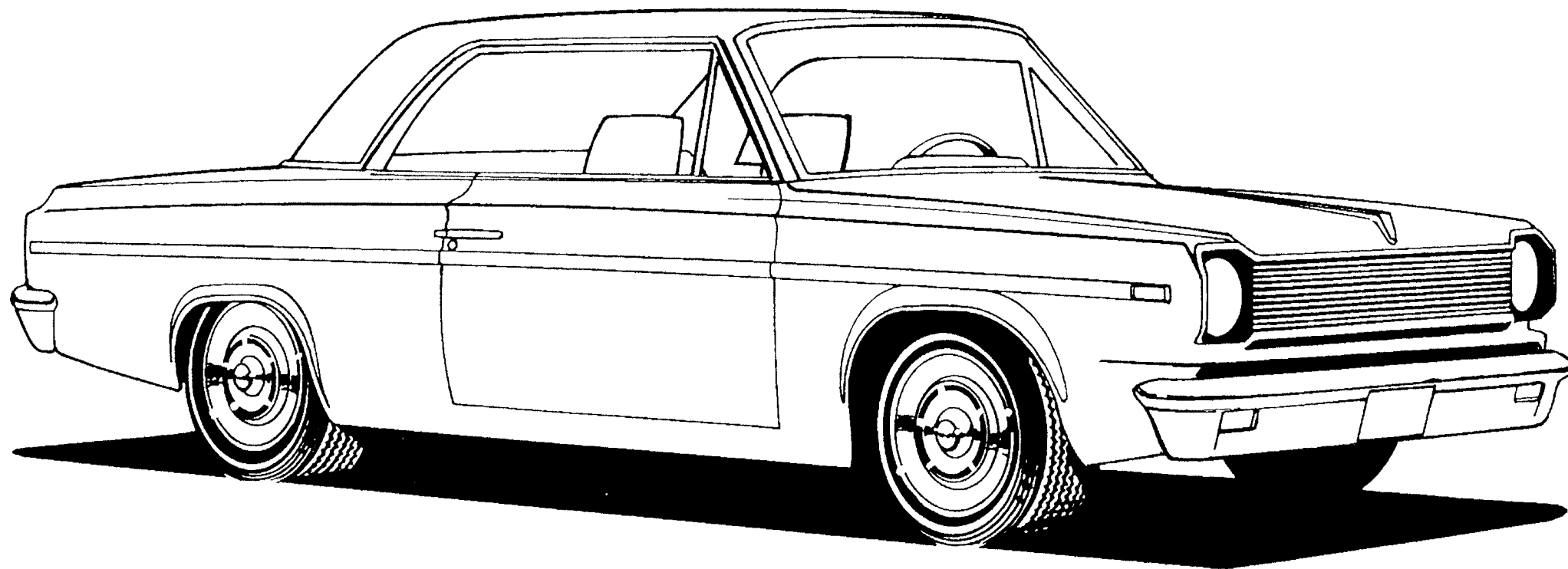

1969 HURST RAMBLER SCRAMBLER



**World leaders in
automotive
finishes.**

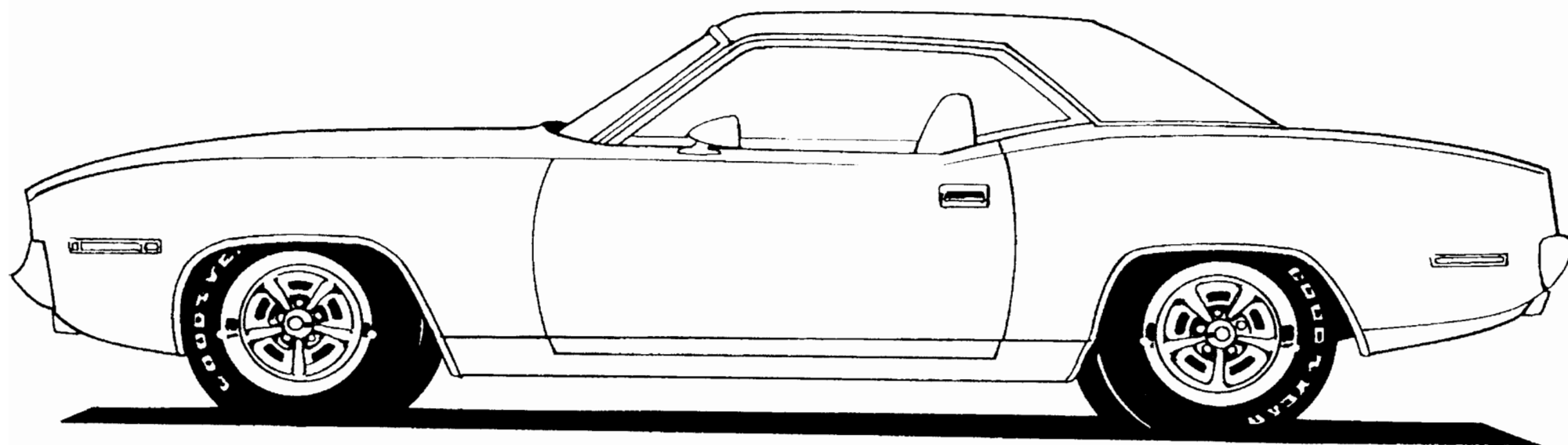

1970 BARRACUDA



**World leaders in
automotive
finishes.**

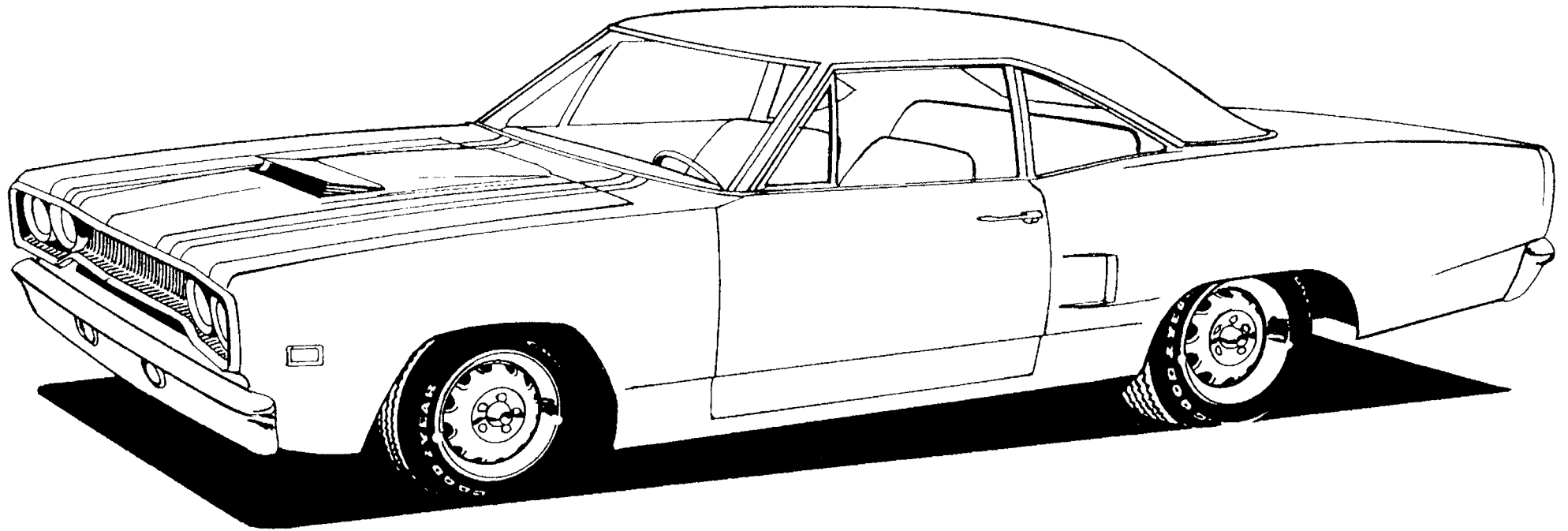

1970 ROADRUNNER HEMI



**World leaders in
automotive
finishes.**

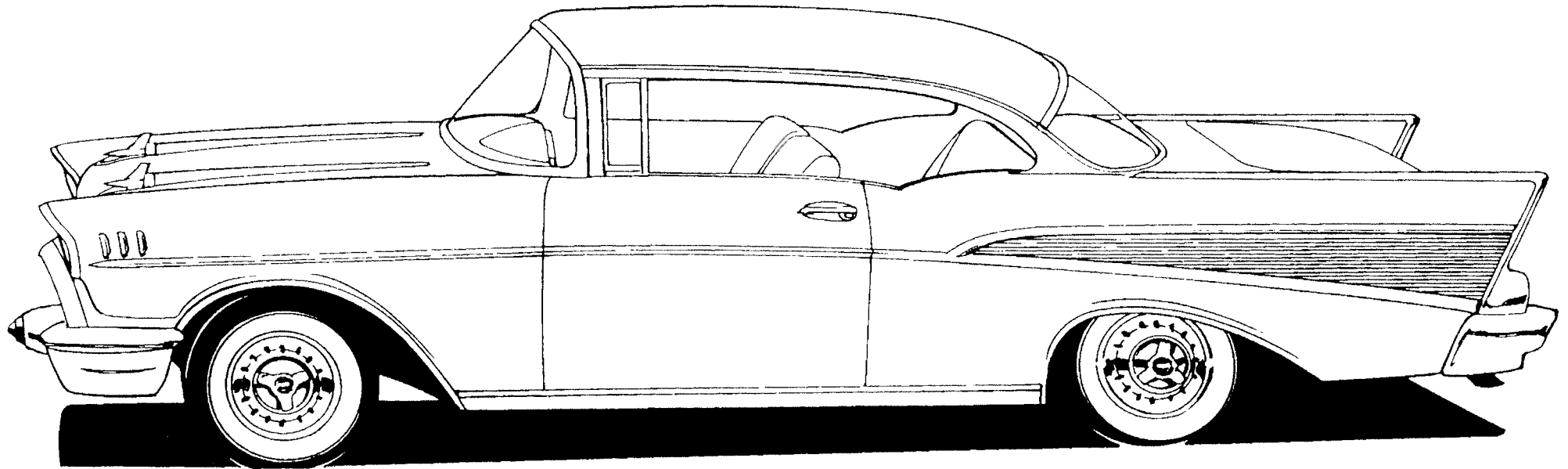

1957 CHEVY



**World leaders in
automotive
finishes.**

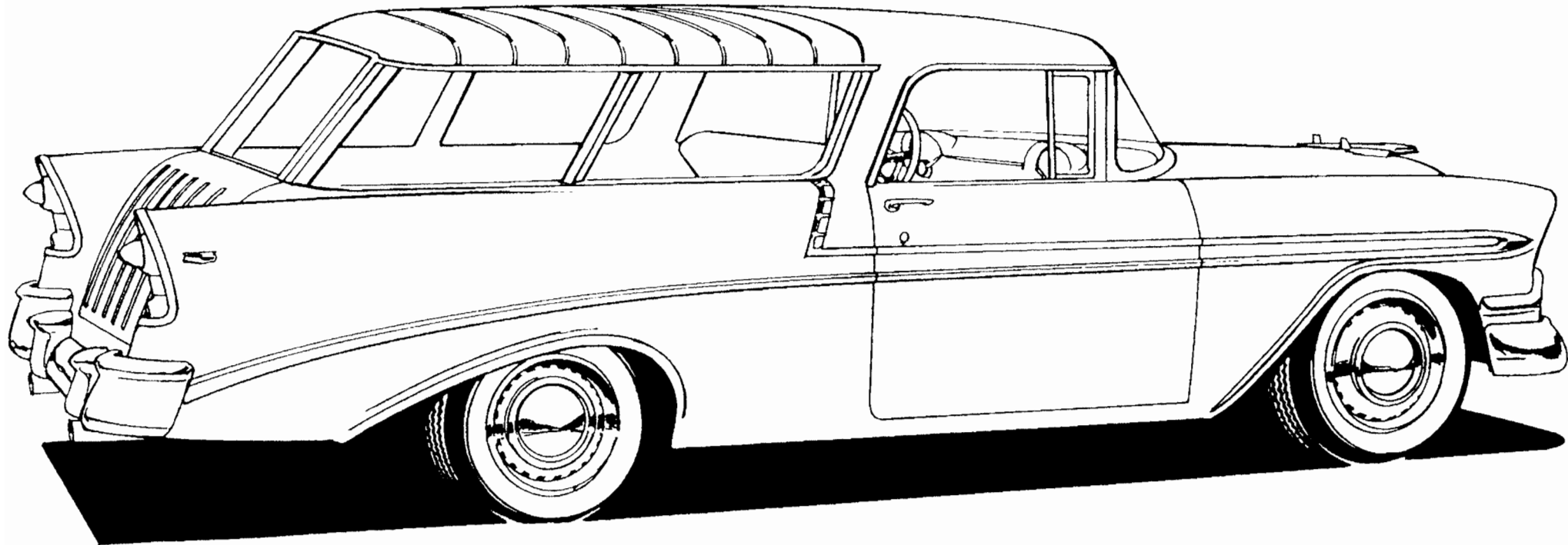

1956 CHEVY NOMAD



*World leaders in
automotive
finishes.*

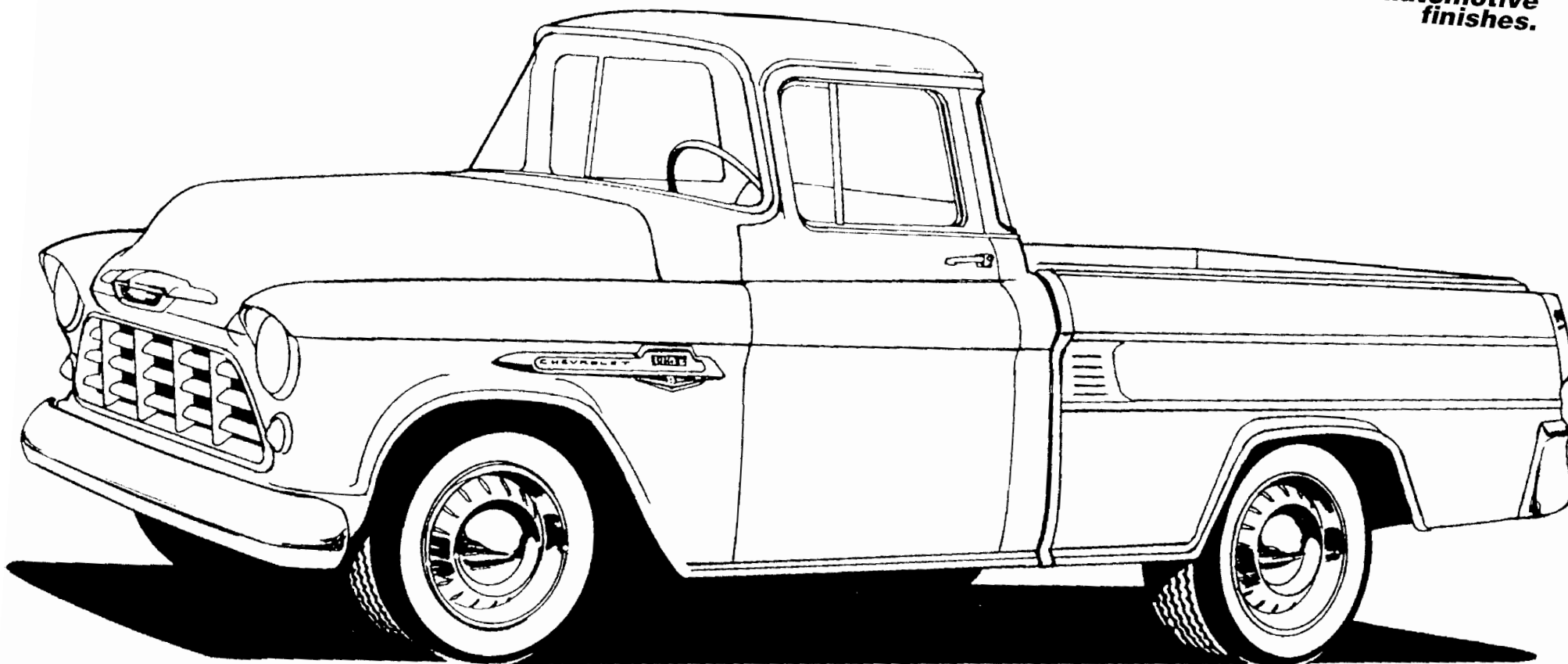

1957 CHEVY CAMEO



**World leaders in
automotive
finishes.**

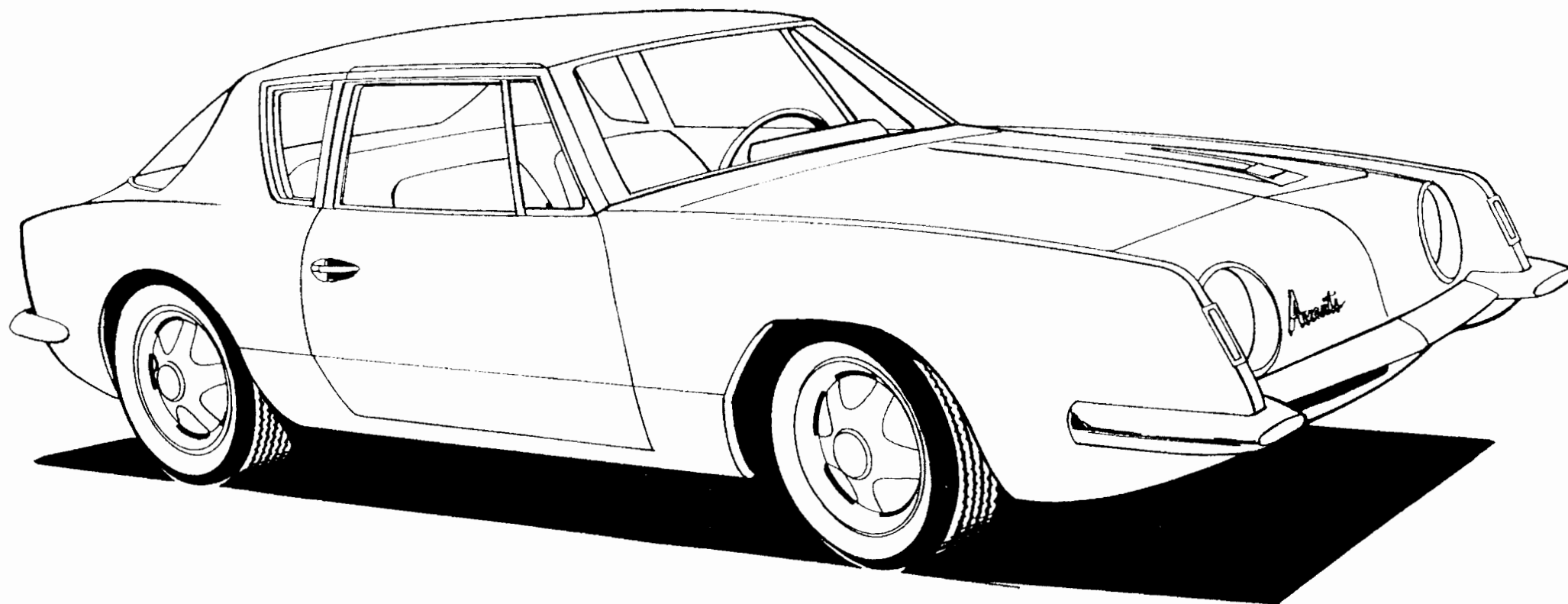

1963 STUDEBAKER AVANTI



**World leaders in
automotive
finishes.**

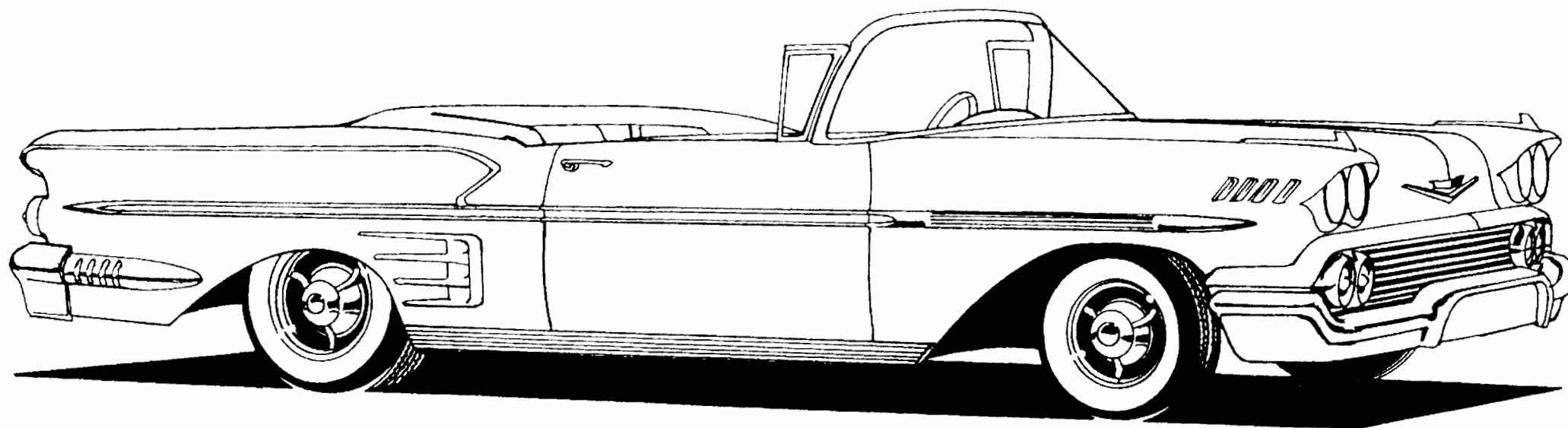

1958 CHEVY IMPALA



**World leaders in
automotive
finishes.**

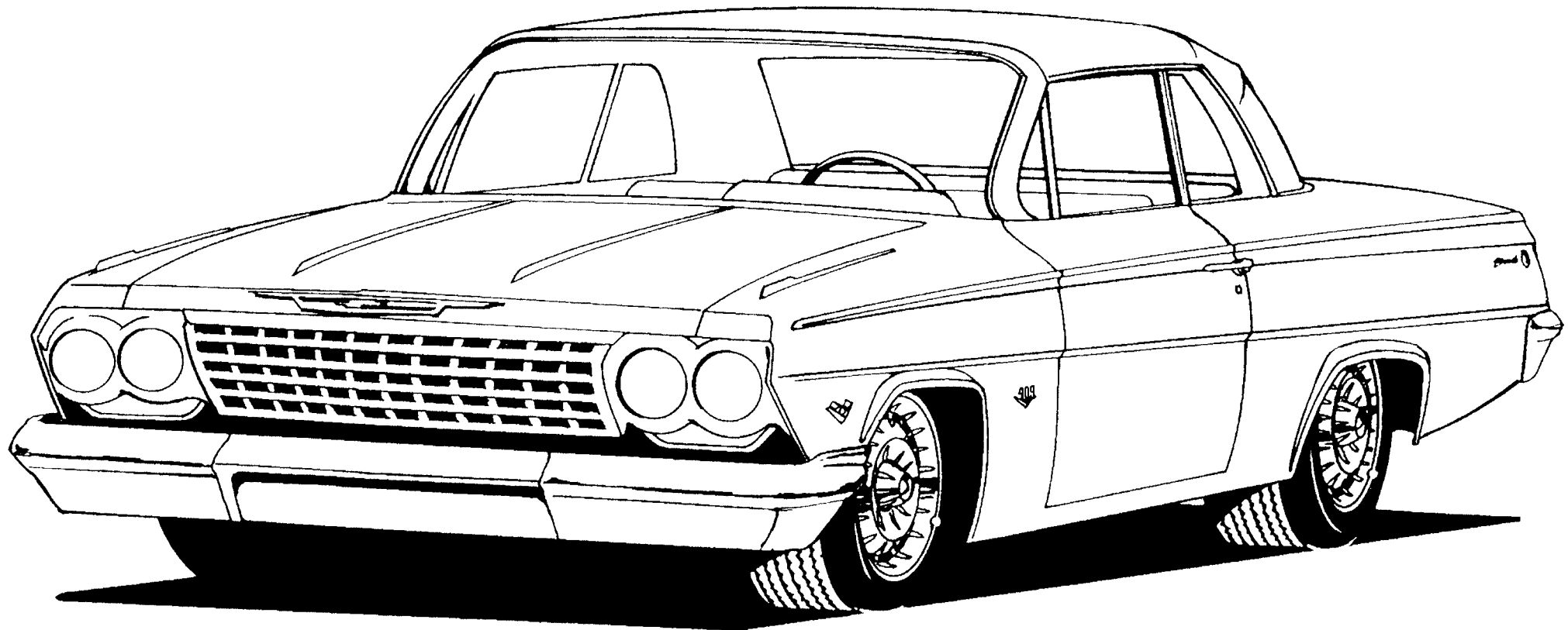

1962 CHEVY 409



**World leaders in
automotive
finishes.**

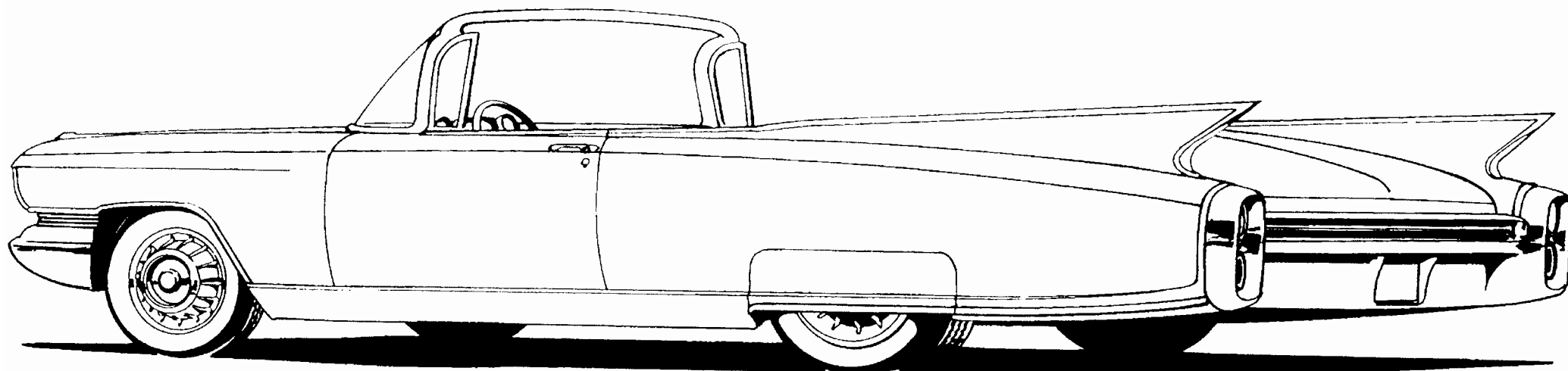

1960 CADILLAC



**World leaders in
automotive
finishes.**

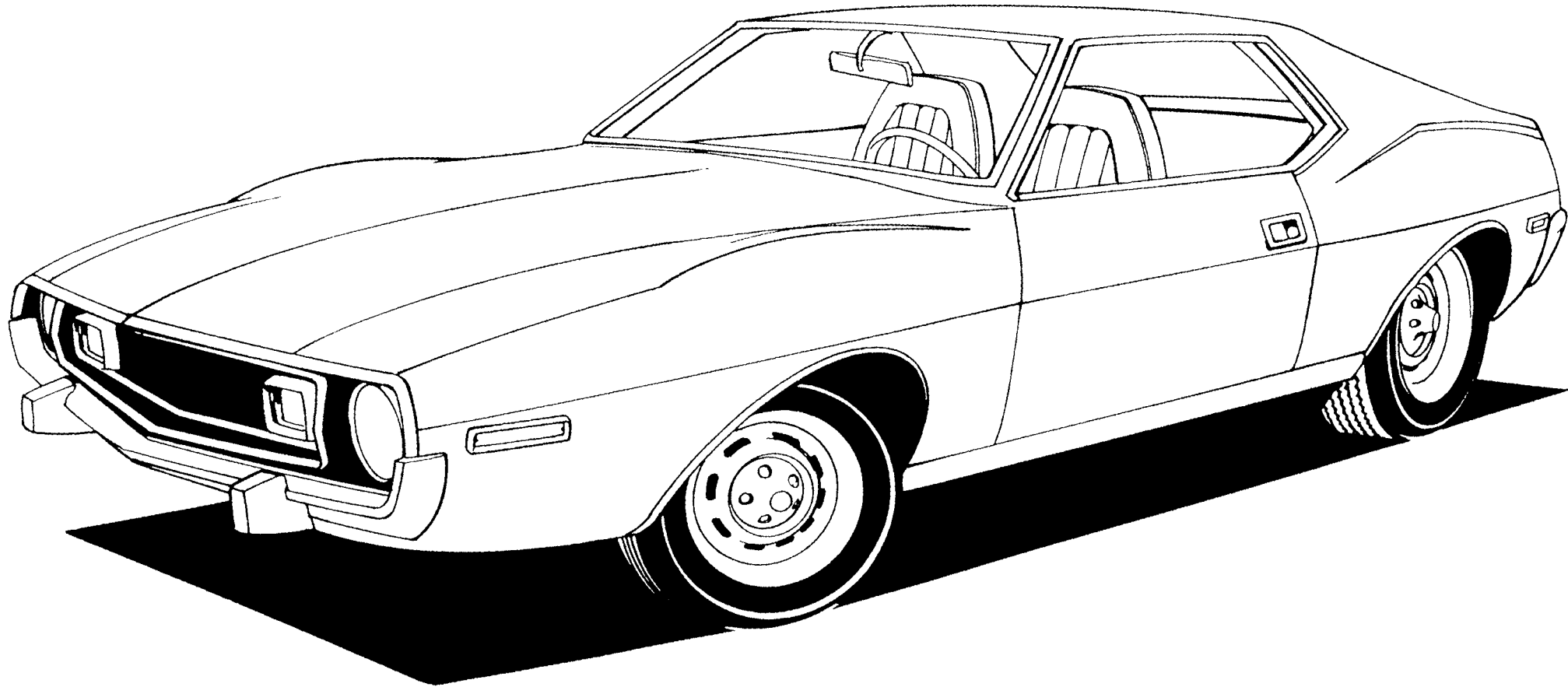

1972 AMERICAN MOTORS JAVELIN



**World leaders in
automotive
finishes.**

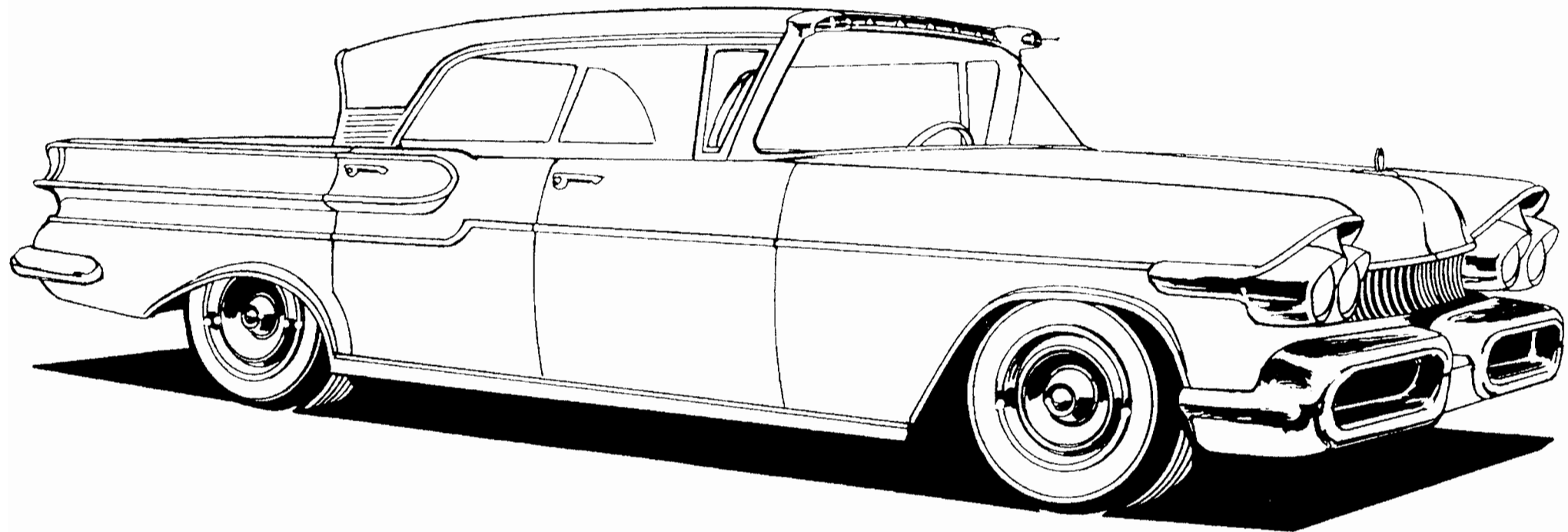

1958 MERCURY TURNPIKE CRUISER



**World leaders in
automotive
finishes.**

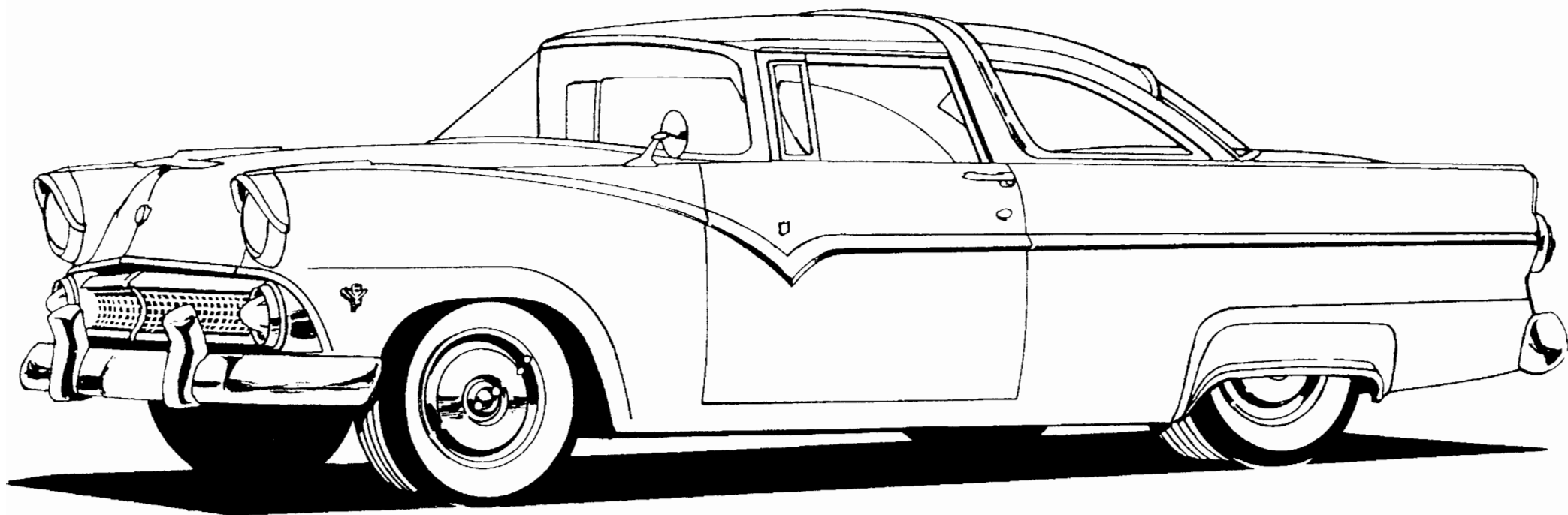

1955 FORD CROWN VICTORIA



**World leaders in
automotive
finishes.**

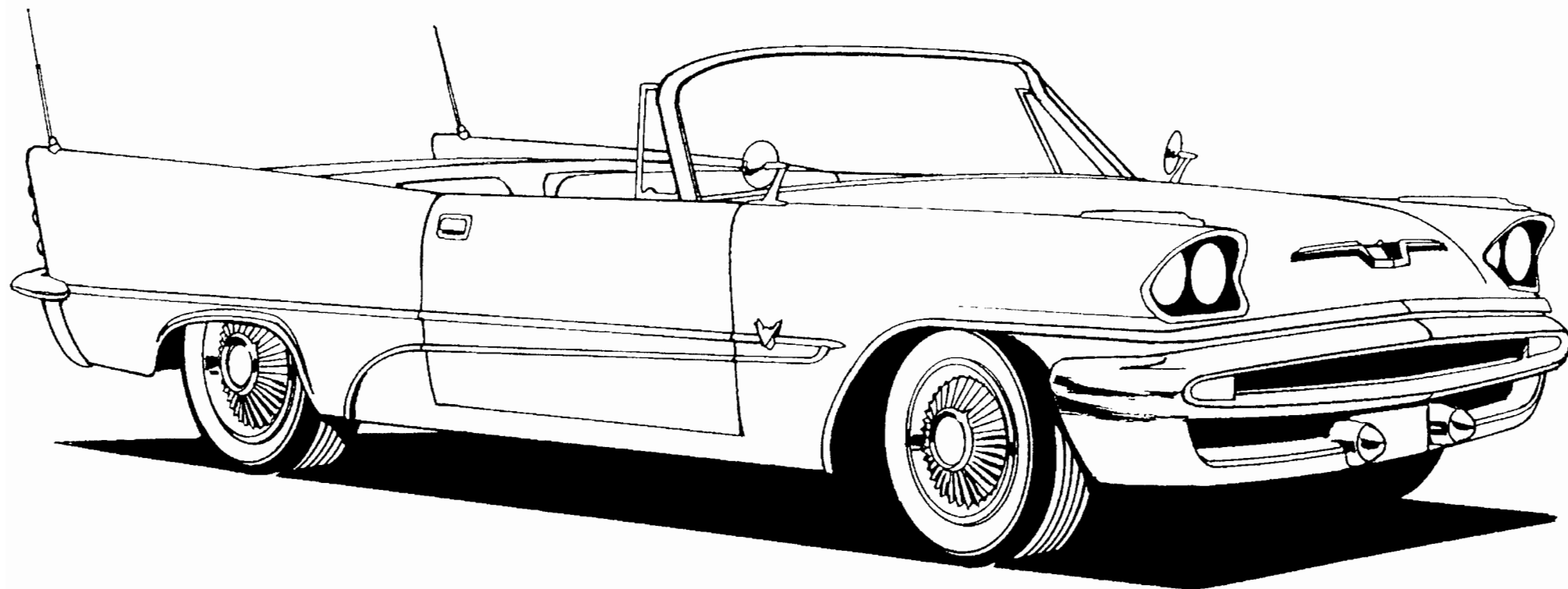

1958 DESOTO SPORTSMAN



**World leaders in
automotive
finishes.**

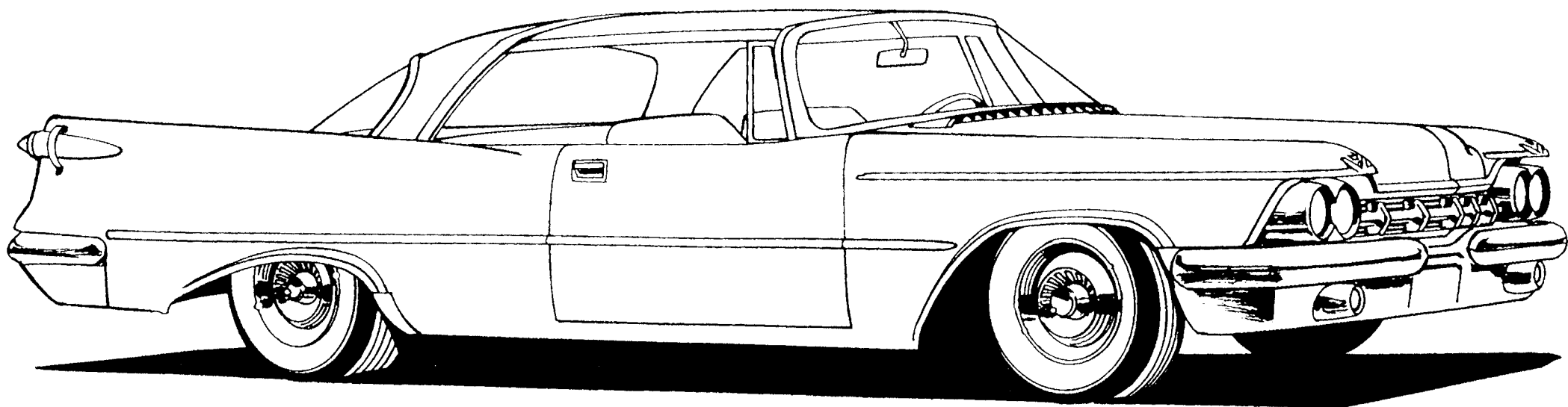

1959 CHRYSLER IMPERIAL